

TECHNICAL AND OPERATIONAL DOCUMENTATION

INSTALLATION AND OPERATING MANUAL AND INSTRUCTIONS FOR SAFE USE

1. Sun protection screen Venetian Blind
- 1.3. Venetian Blinds C80 P, C80 L, C80^{BOX}

PRODUCT NAME:

- SUN PROTECTION SCREEN
VENETIAN BLINDS C80 P, C80 L, C80^{BOX}

PRODUCT MANUFACTURER'S MARKING:

- Manufacturer's name:
SELT Sp. z o. o.
- Manufacturer's head office:
45- 449 Opole, ul. Wschodnia 23A
- Contact details:
Tel: +48 77 553 21 00 (sekretariat)
Fax: +48 77 553 22 00
- Website:
www.selt.com
- E-mail:
selt@selt.com

PRODUCT SAFETY MARKING:

Product conforms to CE safety requirements.

This Technical and Operational Documentation:

- Is valid from: 15 June 2019
- Is valid for product versions designated above

TABLE OF CONTENTS

1.	Introduction	4
1.1.	PRODUCT SAFETY TIPS	4
1.2.	NOTES ON SYMBOLS AND MARKS	4
1.3.	DEFINITIONS.....	5
1.4.	SUBJECT, DESIGNATION AND CONTENTS OF THE DOCUMENTATION	5
2.	Product technical information	6
2.1.	TECHNICAL ParametERS:.....	6
2.2.	PRODUCT CHARACTERISTICS	7
3.	Product transport and storage	7
3.1.	COMPLETNESS AND QUALITATIVE STATE OF DELIVERY	7
3.2.	GENERAL CONDITIONS OF PRODUCT TRANSPORT AND STORAGE	7
3.3.	DESCRIPTIONS THAT HAVE TO BE PUT OBLIGATORY ON THE PRODUCT PACKAGING	7
4.	Product installation.....	8
4.1.	REQUIREMENTS FOR SAFE INSTALLATION AT HEIGHTS.....	8
4.2.	PrEPARATION TO INSTALLATION	9
4.3.	GENERAL GUIDELINES FOR INSTALLATION	9
4.4.	INSTALLATION TOOLS	9
4.5.	INSTALLation.....	9
4.5.1.	Installation of the venetian blind C80 with cover panel.....	10
4.5.2.	Installation of Venetian blind C80 with cube and oval guide rails (self-supporting product)	12
4.5.3.	installation of venetian blind C80 with cube and oval guide rail – group installation.....	15
4.5.4.	installation of venetian blind C80 – motor and cable guide.....	19
4.5.5.	CONCEALED GUIDE RAIL INSTALLATION	21
4.5.6.	WINDOW FRAME GUIDE RAIL INSTALLATION	26
4.5.7.	C80 ^{BOX} WITH UNDER-PLASTER CASSETTE INSTALLATION.....	28
4.5.8.	INSTALLATION OF VENETIAN BLINDS C80 BOX WITH UNDER - PLASTER CASSETTE BOX3, BOX4, BOX5.....	34
4.6.	ELECTRIC DRIVE.....	34
4.6.1.	Connection to power supply	34
4.6.2.	Start-up and adjustment	35
4.6.3.	Manual drive	35
5.	System operation and product safety.....	35
5.1.	General safety requirements	35
5.2.	Safety requirements connected with particular conditions and places of product use.....	36
5.3.	Bezpieczeństwo obsługi	Błąd! Nie zdefiniowano zakładki.
5.4.	Supervision of safe product use.....	37
6.	System use and maintenance	38
6.1.	Using the product in accordance with its intended use.....	38
6.2.	Instructions for non-professionals	38
6.3.	Technical inspections, maintenance and repairs	38
7.	General warranty conditions	39
7.1.	Exclusions for warranty.....	39
8.	Complaints/ technical faults	41
8.1.	Complaints	41
8.2.	Technical faultS.....	41
9.	Product disassembly / utilisation / disposal	41
10.	Marking and labelling the product with the CE mark	42
10.1.	Product compliance with the CE standard	42
10.2.	Information accompanying the CE marking.....	42

1. INTRODUCTION

1.1. PRODUCT SAFETY TIPS

The product was manufactured in accordance with the latest know-how in the area of constructing and manufacturing and is delivered in condition allowing for its safe use.







Safe construction of the external product is achieved by:

No.	Subject	European legal basis	Polish legal basis
1	Shutters and external venetian blinds-Performace requirements including safety	EN 13659:2015	PN-EN 13659:2015
2	Construction products (CPR)	Regulation 305/2011 of the European Parliament and the Council	DZ. U [Journal of Laws] 2004, No. 92, item 881 as amended by, DZ. U [Journal of Laws] 2016, No. 1570; 2015, No. 1165; 2016, No. 542
3	Essential requirements for machines	Directive 2006/42/EC of the European Parliament and the Council	Resolution of the Minister of Economy of 21 October 2008 DZ.U. [Journal of Laws] 2008 no. 199, item 1228 as amended DZ.U. [Journal of Laws] 2011.124

Linked documents: Declaration of performance (external products), Declaration of conformity (product with motor) and manual of installation and use of motors and control.

1.2. NOTES ON SYMBOLS AND MARKS

The below symbols (icons) denote particularly important information concerning threats and safety.

Icon	Icon meaning	Information
	INFORMATION	Prior to using the product, its operating manual should be read. Following the operating manual guarantees: - failure-free use of the product, - warranty coverage against product defects. Keep the operating manual for safety of people.
	INFORMATION	No harmful or dangerous consequences for people or facilities.
	ATTENTION!	A situation likely to cause product damage or other damage. No threat for people.
	WARNING!	Threat of danger
	DANGER!	This symbol denotes all information concerning danger, failure to observe which brings about threat to human life and health. Risk: threat of serious injury or death. Dangerous operation which may cause injuries or product damage.
	WARNING!	Threat to human life or health due to electric shock.
	ENVIRONMENT	Marking on electric or electronic equipment subject to collection in designated places.

1.3. DEFINITIONS

The following terms and definitions used within this documentation shall mean:

Product: Venetian Blind C80 P, C80 L, C80^{BOX}

VENETIAN BLIND: The external sun protection system, installed outside the building, over or inside the window opening building in which lifting and dropping of the aluminum slats is made by the operating mechanism (manual with hand crank, electric with drive connected to the steering system).

SLATS: Part of the product, made of aluminum stripes, that is moved by a steering mechanism, that ensures the product fulfills its function.

BOX: the product in extruded cassette occurring in 5 varieties: BOX1 - extruded two-piece cassette with riveted protrusion made of aluminum sheet for plastering; BOX2 - two-piece extruded cassette with insulation and two riveted protrusions made of aluminum sheet - for plastering and insulation; BOX3 - completely extruded cassette with a slip-on extruded protrusion for plastering; BOX4 - completely extruded cassette with insulation and two extruded protrusions - for plastering and insulation; BOX5 - extruded cassette completely varnished without any protrusions.

1.4. SUBJECT, DESIGNATION AND CONTENTS OF THE DOCUMENTATION

Products manufactured by **SELT Sp. z o. o.** are the subject of this documentation.



Operating manual and instructions for safe use along with the manual for the engine, switches and control shall be submitted to the end user.

**IMPORTANT INFORMATION REGARDING SAFETY
WARNING – FOLLOWING THE MANUAL IS ESSENTIAL FOR SAFETY OF PEOPLE
KEEP THIS MANUAL**

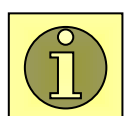

The documentation is valid jointly with the information concerning a specific product, which is available on the website www.selt.com

The documentation includes:

- important recommendations concerning product installation, use and maintenance,
- important recommendations concerning product transport and storage,
- tips following which will assure long-time and fault-free use of the product.

SELT Sp. z o. o. shall not bear responsibility for damage resulting from failure to follow recommendations included in the documentation.

In order to further improve the product, SELT Sp. z o. o. reserves the right to introduce changes which, while maintaining the essential technical parameters, shall be deemed purposeful for improving product operation quality and safety of use.

SELT Sp. z o. o. with a head office in Opole shall hold the copyrights to this documentation. The documentation cannot be used without permission, either partially or as a whole, for any concurrent business activity nor can it be made available to third parties.

2. PRODUCT TECHNICAL INFORMATION

Product technical specification is available at www.selt.com after log in.

2.1. TECHNICAL PARAMETERS:

Maximum dimensions :	Width	Height	Max. area
Electric drive (rail guide)	4500 mm	5000 mm*	
Manual drive (rail guide)	4500 mm (for height. 2000 mm)	5000 mm (for width. 1800 mm)	9 m ²
Electric drive (cable guide)	3500 mm	4000 mm	
Manual drive(cable guide)	3500 mm (for height. 2400 mm)	4000 mm (for width. 2200 mm)	9 m ²
Slat dimension	80,4 mm	12,4 mm	
Available with cable guide or extruded aluminium side guides			
Manual drive			
Crank	Made of anodized aluminium, the length equals to 2/3 system height		
Electrical drive motor of the following parameters:			
- supply voltage	230V/50Hz		
- power	90 to 230 W (depending on the motor type and blind size)		
- current consumption	0,4 do 1 A (depending on the motor type and blind size)		
- protection level	IP 44, IP 54 (depending on the motor type)		
- time of continuous work	4 to 6 mins (depending on the motor type)		
- torque	6 Nm – 20 Nm (depending on blind size)		
- rotation speed	24 lub 26 rpm (depending on the motor type)		
- work temperature	od -25°C do +70°C (depending on the motor type)		
Installation:			
Application	External		
Installation place	To the niche (installation to the wall/ceiling) or on the building facade		

*For OVAL or CUBE cassettes maximum height is 4000 mm

* For C80^{BOX} maximum height is 3000 mm

Detailed data concerning individual motor parameters is available from manufacturer's websites as well as on:

www.selt.com → PRODUCTS → AUTOMATION



Optional application of weather automation additionally protects the product from changeable weather conditions.

2.2. PRODUCT CHARACTERISTICS

The types of products – Venetian Blinds:

- Installed on the outside of the building, operated by a electromechanical drive connected with the operating system,
- Installed on the outside of the building, operated manually with a crank mechanism..

The products are characterised by the following qualities:

- they are designed for installation in the window area,
- they limit the sun light coming into the room,
- they provide disperse light in the room
- they prevent rooms from overheating, thus contributing to the improvement of thermal comfort in rooms,
- they help to limit the costs of air conditioning in the rooms,
- they limit the noise transmission to the inside
- they do not emit any toxic substances during their work,
- emission of noise through a product with electronic drive (connected with work of mechanical parts caused by electric drive during its work) is not said to be a significant danger and it is a way of comfort, the level of acoustic pressure is up to 58dB,
- the motors have the security level IP44 which means that they are prevented from touching elements movable and under voltage with tools and wires of >1mm diameter and that they are protected from splashes of water from any direction,
- the construction of the product and driver allows to stop the slats safely at any height within the up-down work area and stay there suspended.
- up and down movement is performed with the use of crank or an electric switch or with a remote controller,
- casings for the movable parts were designed and performed in a manner assuring safety for operators as long as they are used properly.

3. PRODUCT TRANSPORT AND STORAGE

3.1. COMPLETENESS AND QUALITATIVE STATE OF DELIVERY

Selt Sp. z o. o. makes every effort to ensure that the goods are produced in accordance with the order. To check the completeness of the product is purchaser's duty and it should be conducted at the time of delivery. Any discrepancies of the product with the order should be reported immediately to the driver/warehouseman/installers and noted in the proof of delivery at the risk of losing warranty. Checking the quality of the apparent defects should be done by the purchaser at the time of delivery. As apparent defects are considered mechanical damages, scratches, cracks, etc. Any discrepancies in quantity or possible replacements of parts being the evident result of Selt Sp. z o. o. fault, the company agrees to supplement or replace in the shortest possible time.

3.2. GENERAL CONDITIONS OF PRODUCT TRANSPORT AND STORAGE

List:

- The product is factory-packed in a cardboard box to prevent its damage during storage, transport and during its transportation to the place of final assembly,
- For the transport purposes, the products should be set in accordance with the arrows on the packaging,
- Do not store the products in a number of layers greater than 2 due to the possibility of crushing the package which in turn can lead to permanent damage of the product,
- Products placed on the means of transport must be secured against movement and damage during transport (e.g. spacers, safety belts, etc.),
- During transportation the products must be protected from the rain or snow,
- Storage places should be dry, airy and protected from the harmful effects of weather conditions (sun, rain, etc.),
- Where the weight of the product exceeds 25kg and its transportation to the place of final assembly must be carried out by at least two persons.

3.3. DESCRIPTIONS THAT HAVE TO BE PUT OBLIGATORY ON THE PRODUCT PACKAGING



Before the installation and use of the product its Technical and operation documentation, available at www.selt.com/doc-en, should be read carefully.

4. PRODUCT INSTALLATION

The following part covers general requirements of the product installation.

Proper installation is necessary for efficient operation of the product. SELT Sp. z o. o. recommends to use services of skilled installation crews what guarantees the Purchaser proper installation.

General requirements for safe installation

- it is necessary to follow general rules of construction art,
- it is necessary to follow health and safety regulations, especially concerning work with electricity and at heights,
- the product must be mounted in mechanical way (foams, glues and similar products are not allowed as fastening materials),
- the product should be mounted to permanent elements of the building (walls, lintels, steel structures, aluminum structures, window frames),
- the base where wall-ceiling brackets are mounted should be durable construction (concrete, brick, etc.),
- it is not allowed to mount the product on building structures that does not provide sufficient load-bearing capacity,
- product should be installed on even and dry wall surfaces that at the same time ensure proper strength and are completed according to general rules of building art,
- in case of constructions made of metal, in which components are welded together according to art of joining metal parts, installation is made to the structures of sufficient wall thickness,
- before starting the installation remove all unnecessary elements from the installation area,
- before starting the installation all mechanisms redundant for the drive operation should be immobilized.

Information table

The manufacturer allows the assembly of the product in the following types of substrate (wall-bearing layer):

- non-reinforced concrete or reinforced concrete class min. C20 / 25 unscreened,
- concrete as above with a thermal insulation layer up to 25 cm thick,
- wall min. 24 cm full brick Mz format NF with a strength of min. 20 MPa and density > 1.8 kg / dm³ on the M2,5 to M9 mortar,
- wall min. 24 cm from silicate blocks with a strength of min. 10 MPa and density > 2 kg / dm³ on mortar M2,5 to M9
- wall min. 17.5 cm from silicate perforated blocks with a strength of min. 20 MPa and density > 1.4 kg / dm³ on mortar M2,5 to M9
- wooden beams (wall / ceiling), class min. C24 without cracks at a thickness of min. 100 mm
- wooden rafters, min. C24 without cracks at a thickness of min. 70 mm
- walls made of silicate blocks (full or hollow) with a thermal insulation layer - consultation with an authorized designer is required,
- walls made of solid bricks with a thermal insulation layer - consultation with an authorized designer is required,
- wall made of cavity ceramic fissures without insulation or with a thermal insulation layer - consultation with an authorized designer is required
- cellular concrete blocks - not recommended.

The list above is for guidance only. The suitability of the substrate depends on the specific location and size of the product and must be selected by an authorized constructor

4.1. REQUIREMENTS FOR SAFE INSTALLATION AT HEIGHTS



Installation of the product, because it requires performing work at heights, is particularly dangerous because it poses a high risk of danger to human health and safety and in particular fall from height.

The purchaser is obliged to conduct the installation of the product according to health and safety regulations applicable in a given country. The responsibility of the purchaser is to develop a plan for health and safety protection during installation. Purchaser should determine specific requirements of health and safety when working at height, and especially to ensure:

- direct supervision of work execution by the designated person (e.g. the foreman),
- adequate safeguards measures, in particular protective equipment against falls from height,
- detailed instruction of employees performing work at heights,
- necessity to use ladders with appropriate quality and safety certificates, scaffoldings, safety buckles, platforms with adequate strength for anticipated load.

Work at heights that requires using personal protective equipment against falls from height, must be performed by at least 2 people.

4.2. PREPARATION TO INSTALLATION

- unpack product and check if it contains all necessary elements for installation,
- before starting the installation check the dimensions of window opening with specifications on the packaging,
- make sure that the base where product will be mounted provides sufficient bearing capacity for safe installation and operation of the product.

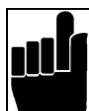

Attention! Pins, screws or bolts to secure the product to the structure depend on the type of substrate, and therefore are not included with the product and its purchase has to be done by the buyer or installer.

4.3. GENERAL GUIDELINES FOR INSTALLATION

- mounting of the brackets and covers should be done with appropriate bolts and pins (they are not included with the product),
- in case of reinforced concrete lintel or solid bricks, dowels should be used for mounting. Make sure their size is correctly selected for bearing capacity,
- depending of the type of the wall structure appropriate mounting system should be selected,
- longitudinal axis of the product head rail should be leveled, otherwise the product will not roll correctly
- the product should be protected against any stains made by e.g. silicon, mortar or mounting foam, which may cause its malfunction,
- using any chemical substances containing bituminous substances or any other substances making reactions with the product is forbidden.



Improper installation may cause hazardous situation for the user.

4.4. INSTALLATION TOOLS

List:

- drills for metal and concrete,
- hummer drill,
- ladder/scaffolding,
- screwdriver,
- hammer,
- tape measure,
- Pencil/pen,
- Spirit level,
- Allen wrenches,
- cutter.

4.5. INSTALLATION

Installation and operating manual and instructions for safe use is available after log in on www.selt.com



Internal mechanisms in the head rail can move during incorrect transport of the product (in vertical position). Therefore one should check the placement if mechanisms in the head rail before commencing the installation.

4.5.1. INSTALLATION OF THE VENETIAN BLIND C80 WITH COVER PANEL

- Before commencing the installation of the blind, measure and mark the placement of main cover panel brackets, so that they do not collide with the motor and rolling mechanisms.
- Connect loosely cover panel bracket extension with the main cover panel bracket (img. 1) and fit them with the cover panel, adjust to its height and secure tightly img 1.



Img. 1

Img. 2

1. Connect the head rail bracket with main cover panel bracket. Then match them to the cover panel, adjust to its height and secure tightly.- Img. 1.
2. Fasten the set of brackets along with the cover panels and side panels (if they occur) to the wall or niche with an adequate tool - Img. 2.
3. Tighten the main brackets to the wall/ceiling



Img. 3

Img. 4

4. Check the level of installed cover panels and brackets, correct if necessary - img. 3. Appropriate leveling of the product is necessary for its correct functioning..
5. Loosen the elastic bracket screw, so that the bracket is easy to open - img. 4.
6. Connect the bundle to an installation cable and open the blind for about 30 cm to facilitate the installation of the bundle to the cover panel.

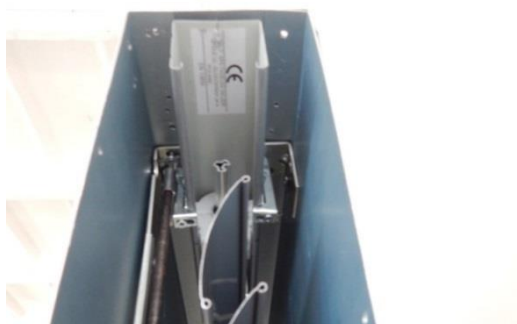

7. Put the head rail with bundle into the brackets, so that the label „this side to window” faces the window.
8. Tighten the screws of the head rail brackets (img. 4).
9. Install the cover panel with side panels (if they occur); (img, 6-7).

Img.5



Img.6



Img. 7

Guide rails types for C80 Venetian Blind with cover panel

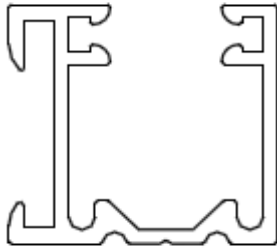

Single guide rail

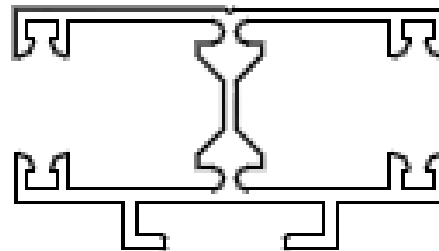

Double guide rail (for modular installation)

Single and double guide rail bracket types



Typ 1 standard

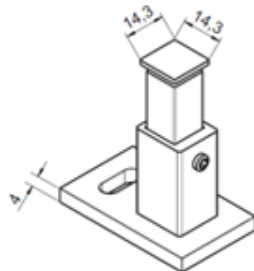

Type 2

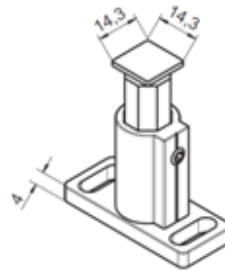

Type 3

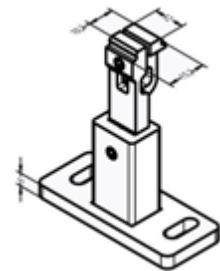

Type 4

Type 4 installation manner

- Loosen the cone shaped screw so that the bracket is easy to click into the guide rail.
- After the fixing is placed in the guide secure the cone shaped screw until it resists.
- The proper tightening should be performed with allen wrench and maximum 180° turn.

NOTE: Bigger turn will result in deformation of guide rail!



Img, 8



Img, 9

Slide the guide rails brackets to the guides. Then secure the brackets in the guides by tightening the cone shaped screw.



10. Slide the guide rail on the slat pins.

Img, 10

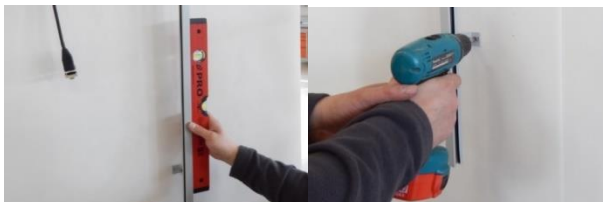

Img, 11

Img, 12

11. Measure precisely the placement of guide rail axis – img, 11.
12. Screw the guide rails to the base – img, 12

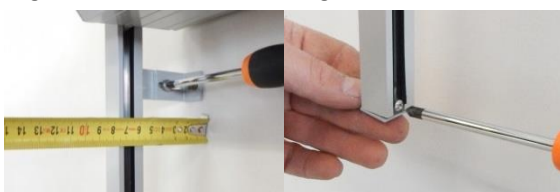

Img, 13

Img, 14

13. Measure precisely the placement of guide rails axis. Then tighten the elements of the bracket – img, 13.
14. Install guide rails end caps – img, 14.

After the installation is finished set the end positions and check the correct functioning of the blind.

4.5.2. INSTALLATION OF VENETIAN BLIND C80 WITH CUBE AND OVAL GUIDE RAILS (SELF-SUPPORTING PRODUCT)

Guide rails for self-supporting installation of C80 Venetian Blind

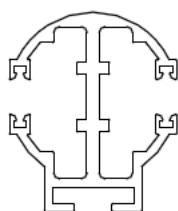

Oval guide rail

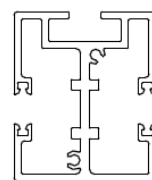

Cube guide rail

Round guide rail bracket – cassette bracket

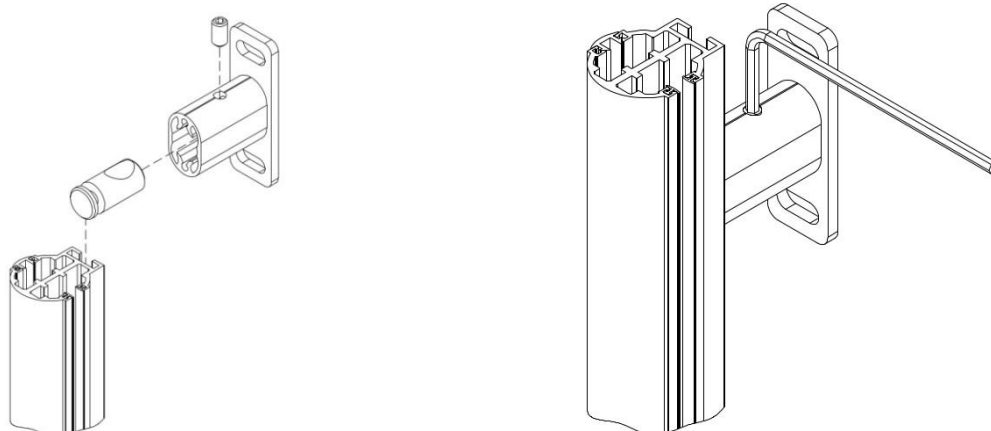

Manner of installation

- Place the fixing element into the guide rail groove.
- Screw the set screw until the resistance is felt with allen wrench no. 4.
- Screw tightening should be done with maximum half-turn (180°).

NOTE: bigger turn will result in breaking the screw out from the bracket.

Self-supporting bracket

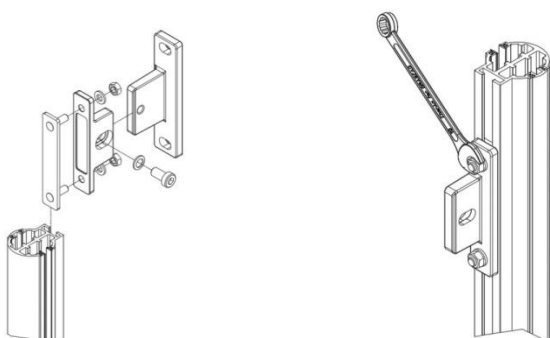

Manner of installation

- Slide the fixing element into guide rail channel.
- Loosely secure self-locking nut until resistance appears.
- Proper tightening should be performed with a wrench (10") and maximum 4 full turns (1440°).

NOTE: bigger turn will result in tearing out the threaded stud!



1. Measure and mark the spots for guide rail brackets installation. Then install the brackets.

Img, 1



2. According to previous measurements, install the brackets to the facade. Number of brackets depends on the product dimensions (img, 2-8). During installation verify the dimensions and vertical and horizontal linearity of the brackets. Correct if necessary. (img, 2)

Img, 2

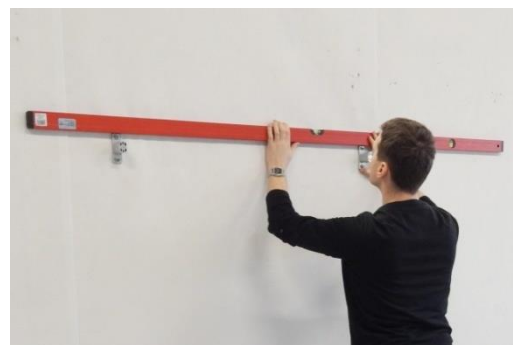

Img, 3

Img, 4

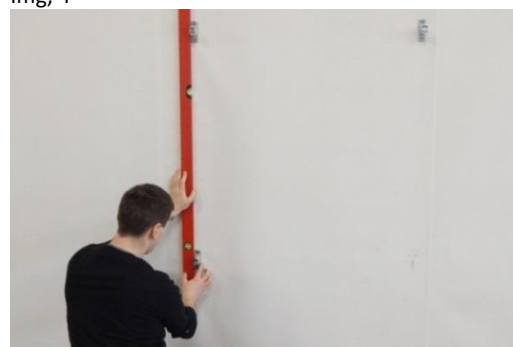
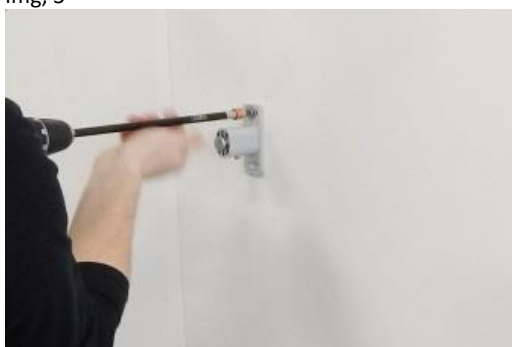

Img, 5

Img, 6

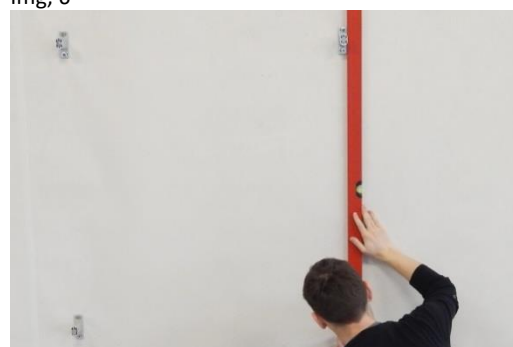
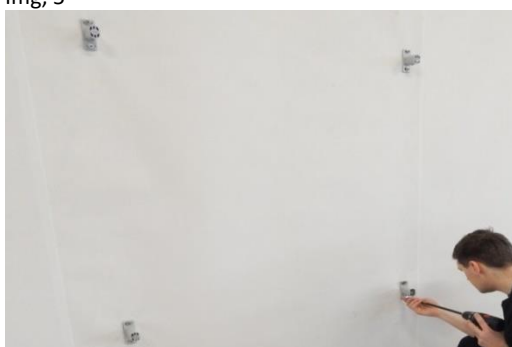

Img, 7

Img, 8



Img, 9

Img, 10

3. Loosen cone shaped screws securing the bolts and pull the bolts out (img. 9 and 10).



Img, 11

Img, 12

4. Slide the guide rails on brackets (img. 11-12).

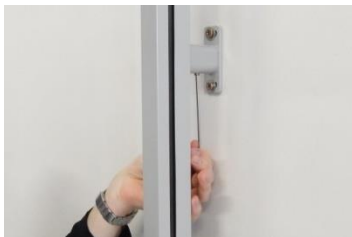

Img, 13

5. Secure guide rails in brackets by tightening the cone shaped screw – img. 13.



Img, 14

Img, 15

6. Check the vertical level of the guide rail.
7. Repeat points 4 and 5 to install the second guide rail - img. 14
8. Check the level of the guides – img. 15



Img, 16

Img, 17

9. Connect head rail brackets to flat bars placed in the cassette – img.16
10. Loosen the installation flat bar on the cassette side - img. 17.

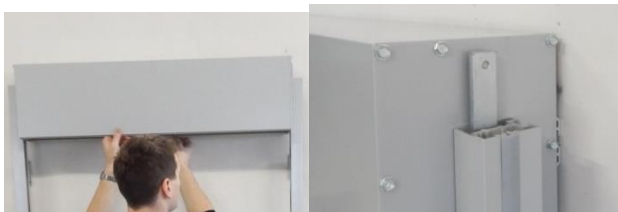

Img, 18

Img, 19

11. Connect the cassette with guide rails by sliding the installation flat bars into the guide rail channel, then tighten the screws with Allen wrench. Make sure that the gaps in guide rail and cassette are aligned (img. 18-20).



Img, 20

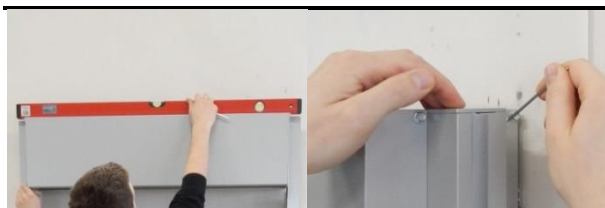

Img, 21

Img, 22

12. Check the horizontal level of the cassette. It is necessary for correct functioning of the product - img. 21

13. Install top end caps in the guide rails - img. 22

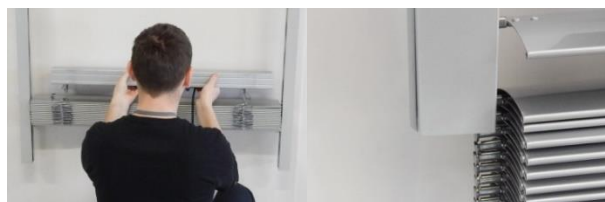

Img, 23

Img, 24

14. Slide the head rail with slats bundle to the guide rails, remembering that the label „this side to window” should face the window. Incorrect installation of the bundle will cause incorrect functioning of the product (it will open contrariwise); img. 23 and 24.



15. Connect the installation cable and open about 30 cm of the blind to facilitate the installation of the bundle to the cassette.

Img, 25

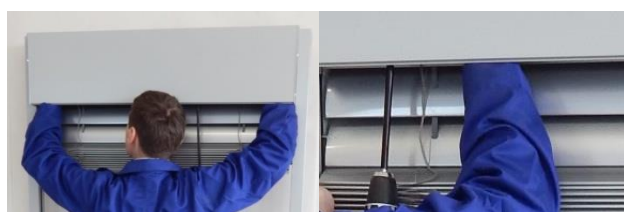

Img, 26

Img, 27

16. Install the head rail with bundle to open head rail brackets. Close the bracket and tighten the screws (img. 26-27).



17. Install bottom guide rail end caps (img, 28).

18. Check the functioning of the blind and end positions. Correct if necessary.

Img, 28

4.5.3. INSTALLATION OF VENETIAN BLIND C80 WITH CUBE AND OVAL GUIDE RAIL – GROUP INSTALLATION

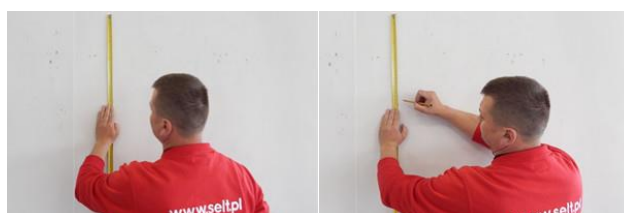

Img, 1

Img, 2

Measure and mark the installation spot of the first guide rail bracket (img, 1-3).



Img, 3



Img, 4

1. Install the bracket to facade with appropriate fixing system (img, 4).

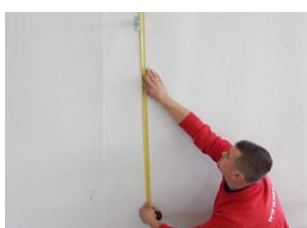

Img, 5

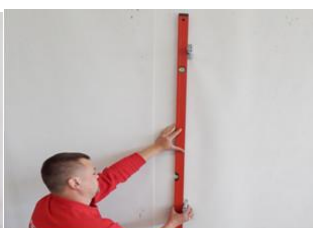

Img, 6

2. Measure and mark installation place of the second bracket (img, 5-6).



3. Install the second bracket.

Img, 7

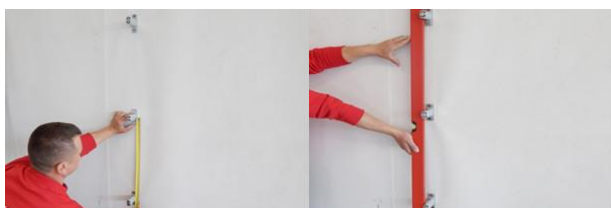

Img, 8

Img, 9

4. Measure and mark the installation spot of the next bracket (img, 8) install the bracket (img, 7).
5. Check the vertical level of the installed brackets, correct if necessary.

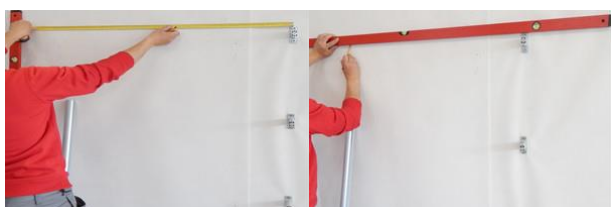

Img, 10

Img, 11

6. Measure and mark the installation place of the second guide rail (img. 10 and 11).



Img, 12

Img, 13

7. Install the next bracket. Measurement and marking for the following brackets should be done similarly to the previous ones – img, 12.
8. Check the horizontal level of the installed brackets – img, 13.



9. Check the vertical level of installed brackets.

Img, 14

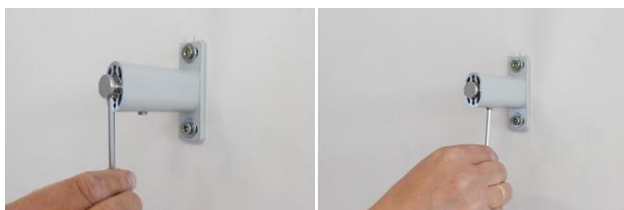

Img, 15

Img, 16

10. Loosen cone shaped screws (img, 15), securing the bolts and pull the bolts out (img, 16).

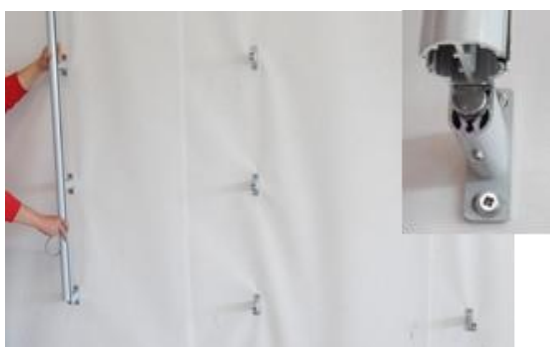

11. Slide the guide rails on bracket bolts (img. 17), settle the guide rail (img. 18) and with Allen wrench tighten the cone shaped screws (img. 19). Install consecutive guide rails.

Img, 17



Img, 18



Img, 19

12. Check the level of installed guide rails (img, 20).



Img, 20

Img, 21

13. Loosen the installation flat bar in the cassette so that it can be slide on the guide rails - img. 21.



14. Install to the cassette elastic head rail brackets and guide rail brackets.

Img, 22



- Put the cassette on guide rails.

Img, 23



Img, 24



Img, 25

- Check the vertical and horizontal level of the cassette (img, 24-25).



Img, 26



Img, 27

- Tighten the installation screws – img, 26.

- Install the middle guide rail - img. 27.



- Insert the head rail with bundle to the guides.

Img, 28



- Put the head rail with bundle into the open bracket, so that the label „this side to window” faces the window.

this side to window
 diese Seite zum Fenster
 ce coté vers fenêtre

Img, 29

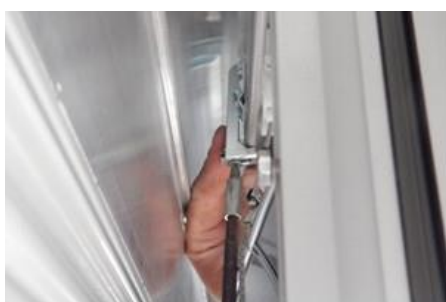

- Tighten the screws in head rail brackets.

Img, 30



22. Install the consecutive bundles to brackets.

Img, 31



Slide the cover profile to external guides (img. 32) and cut the excess at the level of the guides edges (img. 33).

Img, 32

Img, 33



23. Put the guide rails end caps – (img. 34) and secure the locking screw with a triple square key (img. 35.)

Img, 34

Img, 35

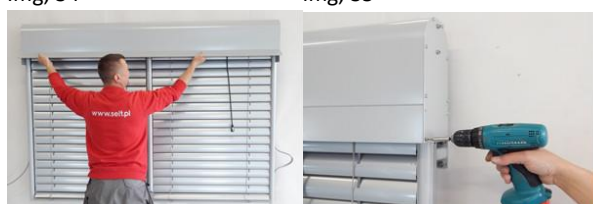

24. Install the revision cover (img. 36 – 37).

25. With the installation cable check the correct functioning of the product and setting of end positions.

Img, 36

Img, 37

4.5.4. INSTALLATION OF VENETIAN BLIND C80 – MOTOR AND CABLE GUIDE



1. Pre-install the cable bracket to head rail, so that further adjustment is possible (img. 1).

Img, 1

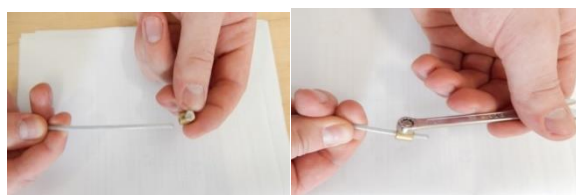

2. Put the bush on the cable guide (img. 2). Tighten the screw, first with fingers until a resistance is felt, then use a flat wrench (img. 3), performing two full turns. Exceeding this scope results in overtightening the screw head.

Img, 2

Img, 3



3. Put the cable guide through opening in the cable guide bracket and slats.

Img. 4



4. Put the cable guide bracket in such a position on the head rail so that the cable does not touch the edges of opening in the slats and secure it.

Img. 5



5. With the use of spirit level mark the place of cable guide bracket installation.

Img. 6

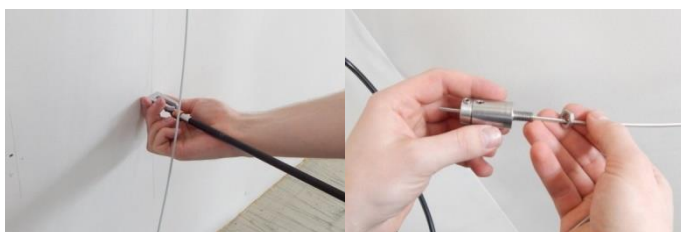

Img. 7

Img. 8

6. Install the angle bracket to the base- img. 7.
7. Put the cable through facade tightener- img. 8.



8. Install façade tightener to the bracket.

Img. 9



Img. 10

9. Secure the cable tightener by tightening the conical screw until a resistance is felt. Then use a Allen key performing 1,25-1,5 full turn, bearing in mind to leave some clearance required for correct tightener functioning. Exceeding the scope mention above results in damaging the screw socket or the wrench ending.



Img. 11

Img. 12



Zdjęcie 13

Zdjęcie 14

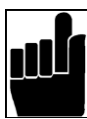

1. Check if the brackets are installed in a secure manner – their movement apart can cause threat to people.
2. After finished installation check the correct functioning of the blind and set end positions according to the motor manual.
3. Do not pull cable guides, it might rip them apart or damage the fixing of upper brackets.

10. Loosen upper screw (locking movable part of the tightener). Stop when the movable part pulls out- img.11.
11. Cut out the excess of the cable- img. 12.

12. Check the vertical levels of the cable. If necessary, correct by moving the tightener in the bracket – img. 13

13. With the use of spirit level set the installation spot of the second cable guide bracket. Other steps should be performed in the same order as when installing the first bracket (img. 14).

4.5.5. CONCEALED GUIDE RAIL INSTALLATION

a) Guidelines for installation

Application of concealed side guides is especially recommended for installation of venetian blinds in deep recessed windows. Using concealed guide rails does not decrease window opening as compared with other kinds of guide rails. Cover panels for venetian blinds with concealed side guides are made without side covers. Width of cover panels equals width of window recess.

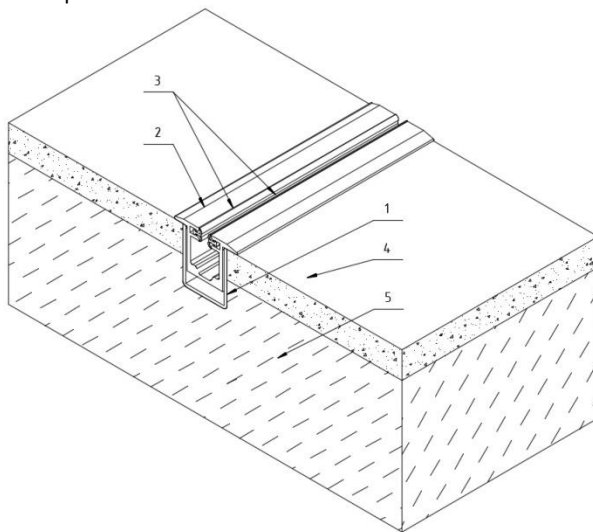

Fig. 1. Concealed side guide system:

- 1 - Mounting profile,
- 2 - Concealed guide rail,
- 3 - Gasket,
- 4 - Plaster/ Insulation,
- 5 - Concrete/ Brick wall.

Guidelines for installation of mounting profile:

- Length of mounting profile equals total height of venetian blind minus 50 mm.
- Installation of the profile is shown in Fig. 2.
- Profile must be secured firmly to the base (cannot be loose) and be in linear and perpendicular position in relation to the blind. In case of the base not being stable enough, it is necessary to provide supporting substructure that will provide stability and correct profile alignment.
- Profiles must be mounted parallel to each other in all planes.
- Profile must be positioned in the way that its upper edge is on the same level with plane of the plaster/ insulation or other finishing material, and in the same level with upper plane of the cover panel.
- Mechanical anchoring of the profile is acceptable in a way that the anchor doesn't protrude more than 4 ÷ 5 mm over the inner wall of the profile, Fig. 3.
- During installation of the profile, you must protect it against damage or dirt from the finishing construction works.

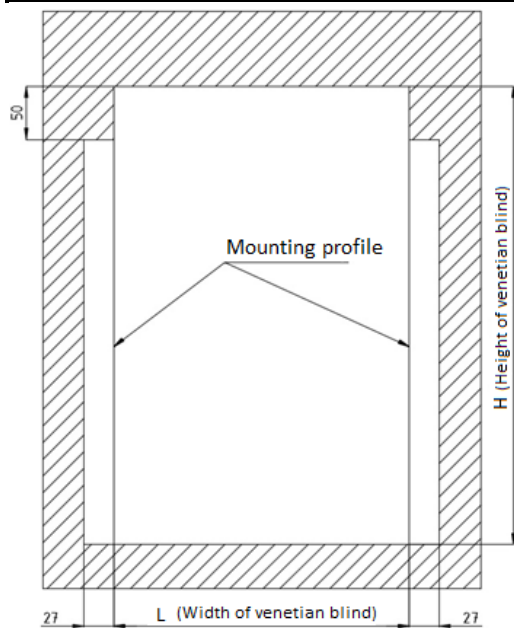

Fig. 2. Installation of mounting profile in window niche.

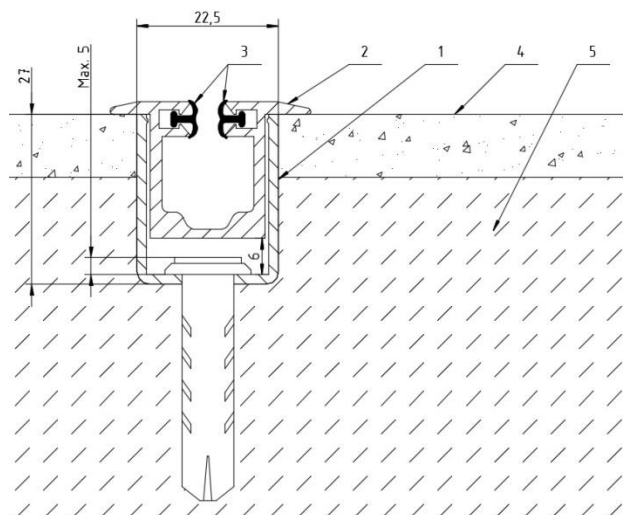

Fig. 3. Positioning of the mounting profile in window niche:

- 1 - Mounting profile,
- 2 - Concealed guide rail,
- 3 - Gasket,
- 4 - Plaster/ Insulation,
- 5 - Concrete/ Wall.

Taking measurements for venetian blinds with concealed side guides is possible after installation of mounting profile. Measurements are taken by the Ordering Party who is responsible for their correctness. In case of dimensional inconsistency of the ordered system that is caused by measurements quality, SELT Sp. z. o. o Company is not responsible for venetian blinds not being possible to be mounted correctly.



ATTENTION: Application of concealed side guides requires initial preparation of the building for installation of venetian blinds. Ordering Party is responsible for correct installation of the mounting profile. SELT Sp. z o.o. company is not responsible for incorrect operation of the blinds resulting from incorrect installation of mounting profile.

Recommendation for taking measurements for venetian blinds order with concealed side guides..

- Measurements are taken from the top edge of the mounting profile that levels with plane of the plaster/ finishing material of the window niche.
- For the single blind, the width is described in Fig. 4a.
- Modular installation – double- and multiblind – requires determining of how the blinds are divided. The division line is located in axis of the double side guide. Blinds are shown in Fig. 4b and 4c.
- For each blind/ group of blinds it is necessary to take minimum 3 measures: at the ends of side guides and in the middle of the side guide.
In case of single blind the width of the blind is the distance marked as L max
- In modular systems – double and multimodular, there is total width of the group marked as L max and widths of individual blinds marked as L1, L2, L3, L.....

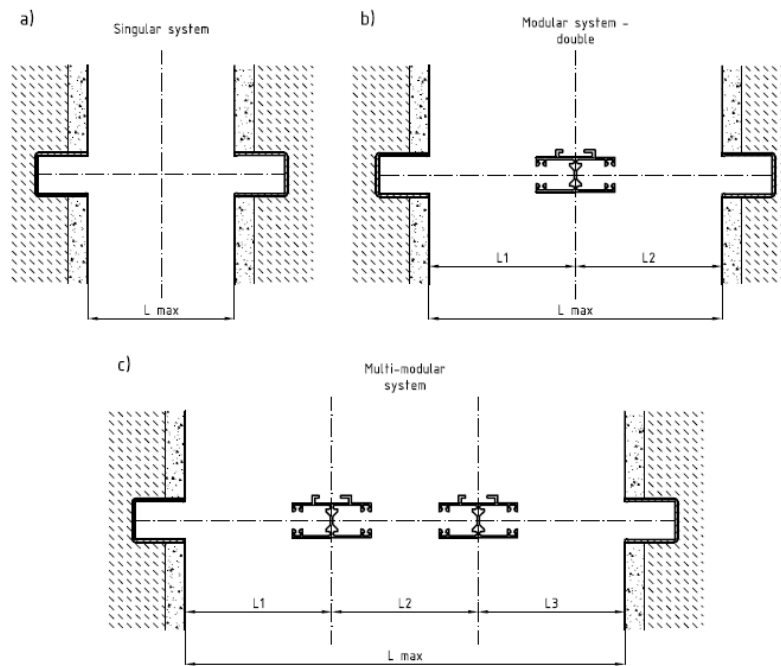

Fig. 4. Measurements of venetian blinds with concealed side guides:

- a) - Single system,
- b) - Two blind module,
- c) - Multi-blind module.

Installation of venetian blind with concealed side guide.

- Before installation you must determine and mark location of the cover panel's main brackets, so they don't interfere with lifting mechanisms and with the motor.
- Initially fix the auxiliary bracket to the main bracket. Then put them against cover panel, adjust to proper length and tighten the screw. Picture 1.



ATTENTION: For the time of drilling side guide and mounting profile and fastening them with tapping/self-drilling screws, you must remove gaskets from the side guide and protect them against damage. Then, reinstall them.

b) Assembly method.



1. Fix head rail bracket to the main cover panel bracket. Fastened brackets put against cover panel, adjust to proper height and screw together.

Picture 1



2. Assembled cover panels with their brackets secure to the wall/ niche with proper bolts.
3. Then bolts of main cover panels to the wall/ceiling.

Picture 2



4. Check level of mounted covers with their brackets, adjust if necessary. Proper levelling of the assembled system is essential for its proper operation.

Picture 3



5. Measure the distance from the bottom of head rail to the underneath of bottom bar (of the rolled up blind).

Picture 4



6. From the guide rail cut off a length measured in Step 5. Follow the step for the second guide rail.

ATTENTION: In the bottom part of guide rail the edges that guide the gasket are kneaded. The section of guide rail that is cut off should be cut from the upper part of the rail.

Picture 5



7. Section of the cut off guide rail install in the upper part of mounting profile, using tapping or self-drilling screw, as shown in Fig. 5. The head of the screw should not block pins in the slats. Follow the step for both guide rails

Attention: in case of using tapping screws it is recommended to pre-drill guide rail and mounting profile accordingly to diameter of the used screw.

Picture 6

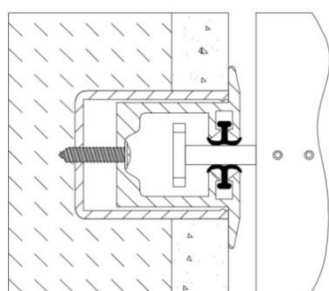
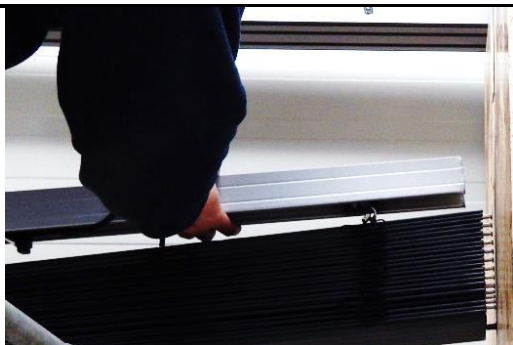

Fig. 5



8. Put the bundle of slats with head rail within the mounting profiles (for convenience of installation put the bundle at slight angle, so the pins are not damaged)
9. Lift the bundle to the top to install the head rail in its brackets. You should pay special attention to properly insert the pins in cavity of the guide rail (mounted in top part of the mounting profile).

Picture 7



10. Loosen the screw in elastic bracket of head rail to easily open the lock in the bracket.
11. Insert the bundle in head rail bracket and secure the bracket.
12. Connect the motor to the power supply.
Attention: The bundle should end at the same height as the mounted top part of the guide rail ends.

Picture 8 and 9



13. Prepare installation of the remaining section of the guide rail in the mounting profile (pre-drill holes for tapping screws to fasten guide rail). Then insert the gaskets into that section. The gaskets will be longer than the guide rail (longer with length of cut off section of guide rail).

Picture 10

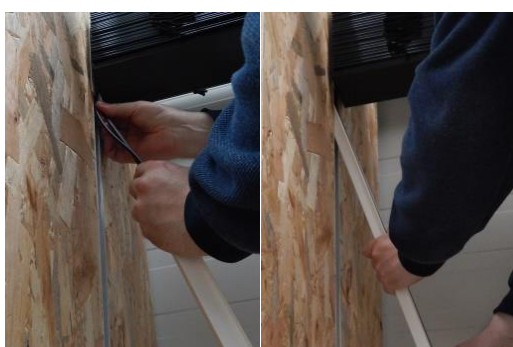

14. The extending parts of gaskets insert into previously mounted guide rail section. Then put the remaining section of guide rail into mounting profile.

Picture 11 and 12

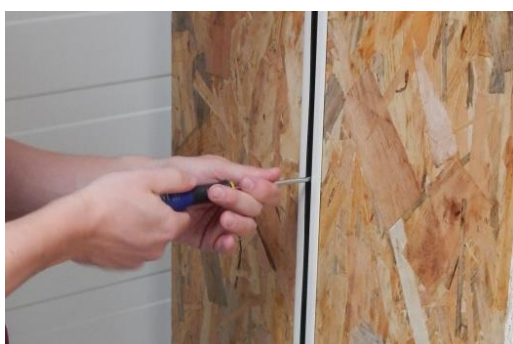

15. After placing the guide rail in mounting profile secure it with tapping screws or self-drilling screws, as shown in Fig. 5

Picture 13



16. Install cover panels to auxiliary brackets
17. Check correct operation of the blind.

Picture 14

4.5.6. WINDOW FRAME GUIDE RAIL INSTALLATION

a) Installation guidelines.

Application of window frame guide rail is advised for the installation of Venetian Blind on facades with the effect of reduction of the clearance between guide rail and façade or in window niches. With application of window frame guide rail for niche installation only cover panel without end caps is available, the width of the cover equals width of the niche

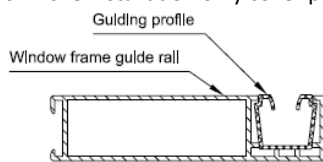

Fig. 6. Window frame guide rail - elements

Guidelines for window frame guide rail installation:

- Length of the guide rail profile equals height of the system -50 mm.
- Fig. 7a shows window frame installation, Fig. 7b shows niche installation.
- Installation of the guide rail must be fixed to the base, as well as it should be linear and perpendicular to Venetian Blind.
- Guide rail profiles must be installed in parallel to each other in all planes.



SELT Sp. z o.o. company is not responsible for incorrect operation of the blinds with guide rail if the substructure does not provide straight and parallel installation of guide rail profiles.

Recommendations for installation of Venetian Blind with window frame guide rail.

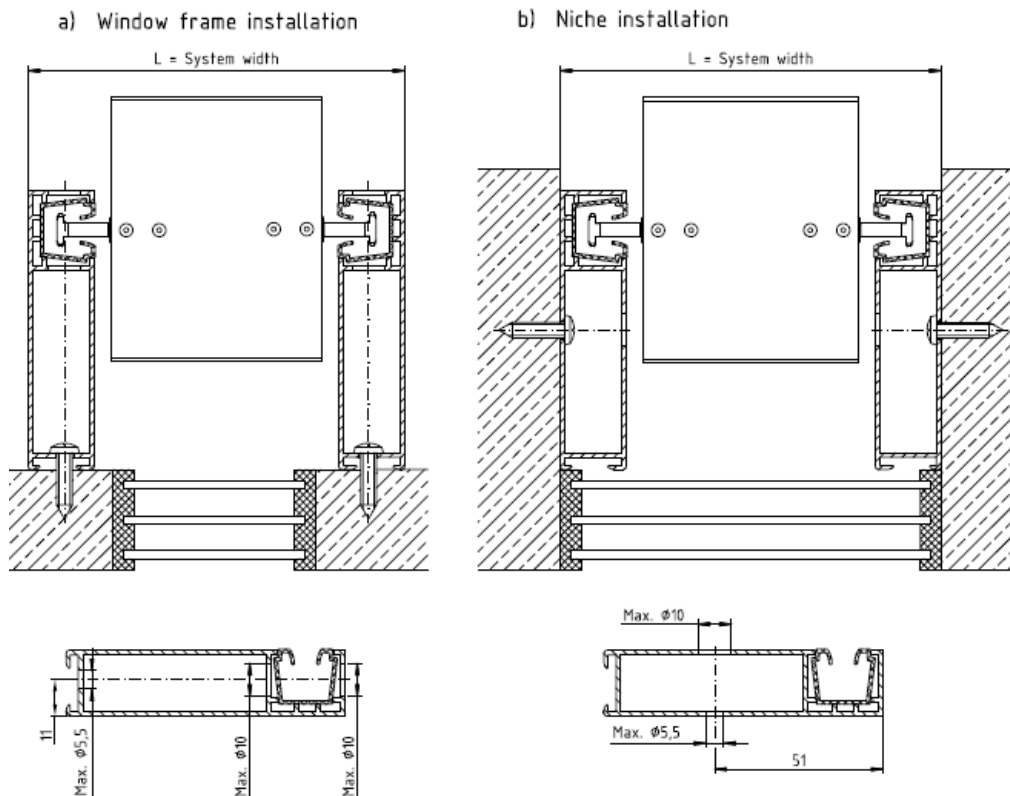

Fig. 7. Window frame guide rail installation: a) – window installation b) – niche installation

Installation of Venetian Blind with window frame guide rail.

- Before commencing the installation of Venetian Blind it is necessary to measure and mark the placement of main brackets for cover panel in such place so that they do not collide afterwards with rolling mechanisms and motor..
- Join the main bracket with auxiliary bracket loosely. Measure them to cover panel, adjust to its height and secure tightly. Img. 1.

b) Installation.



1. Connect head rail bracket to the main bracket. Measure to the cover panel, adjust and secure tightly.

Img. 1

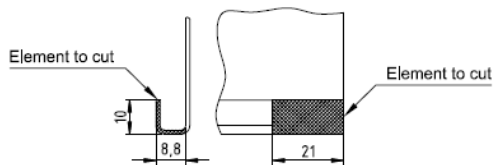

NOTE: For installation on window frame in the rear part of cover panels type 2, 4 and 4a it is necessary to cut on the left and right side small piece to enable the installation of guide rail. The cut should be done according to scheme from fig. 8

Fig. 8



Img. 2



Img. 3

2. Fasten to wall or niche the set of brackets with cover panels.
3. Tighten main brackets to wall/ceiling- img. 2.
4. Check the level of installed covers with brackets, correct if necessary. Correct leveling of the system is necessary for its correct operation - img. 3.



Img. 4

5. Drill mounting holes in the guide rails according to the above description- img. 4.

NOTE: Guide rails can be delivered pre-drilled if agreed with advance. Preparation of mounting holes is a service subject to additional costs.



Img. 5

6. Measure and mark mounting places for guide rail- img. 5
7. Make installation holes for window frame guide rail.



Img. 6

Img. 7



Img. 9

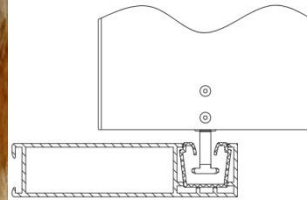

Fig. 9.



Img. 10

Img. 11



8. Install window frame guide rail to window or window niche - img. 6.
9. Slide head rail with bundle into guide rails, so that the label „this side to window” faces the window. Incorrect installation of the bundle will cause incorrect operation of the blind. For easier installation the bundle can be tilted, so that the pins are not damaged – img. 7.
10. Lift the bundle and install head rail in brackets. Pay attention so that the pins are introduced correctly into the guide rail.
11. Loosen screws of elastic brackets so that they are easy to open.
12. Install head rail in bracket and secure the previously loosened screws.

Img. 8

13. Place guiding profile inside the guide rail according to img. 9 and fig. 9, profile should be aligned with the upper Edge of guide rail

NOTE: Pay particular attention so that during guiding profile installation it is not damaged by pins

14. Place profile on whole length of the window frame guide rail- img. 10.
15. Immobilise the ends of guiding profile with silicone installation glue or silicone hot glue - img. 11.

16. Install cover panel to auxiliary brackets- img. 12.
17. Check correct operation of the blind.

Img. 12

4.5.7. C80^{BOX} WITH UNDER-PLASTER CASSETTE INSTALLATION

Types of BOX Cassette:

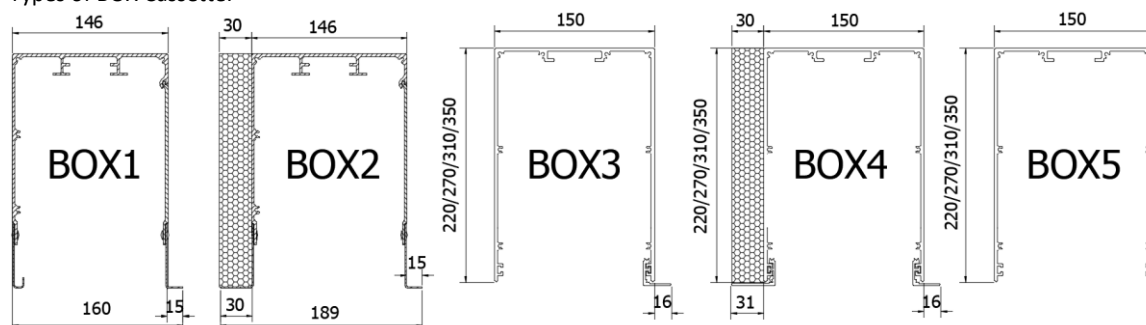

a) Installation guidelines.

Application of system with under-plaster cassette is advised for the installation of Venetian Blind on facades with thermal insulation. Under-plaster cassette limits the effect of thermal bridge and provides aesthetical finishing of the façade without reducing the light of window opening, as opposed to other guide rail systems. Scheme of the system is presented by Fig. 11

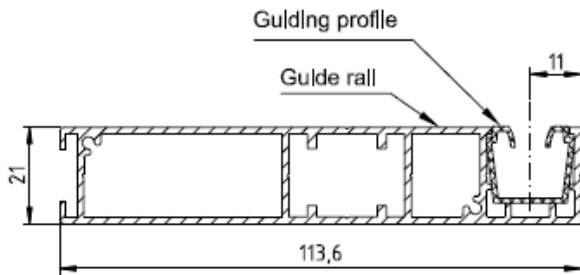

Fig. 10. Guide rail for under-plaster cassette – elements.

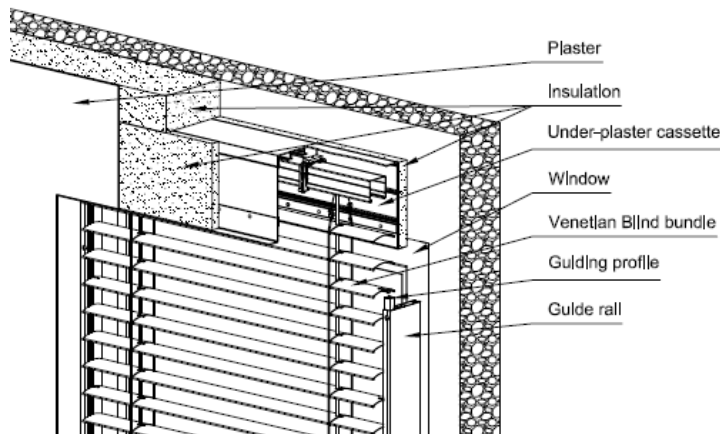

Fig. 11. Venetian Blind C80 BOX – with under-plaster cassette.

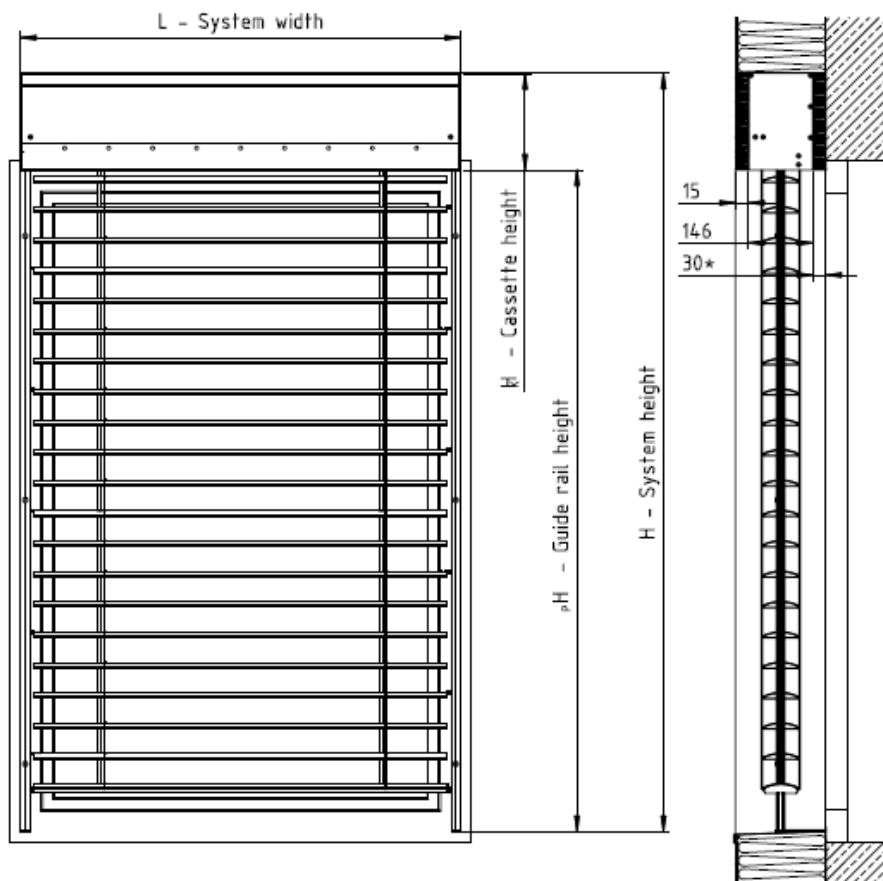

Fig. 12. Dimensions of Venetian Blind C80 BOX – with under-plaster cassette. * - Variable dimension, usually 30 mm.

Guidelines for under-plaster cassette installation:

- Length of the guiding profile installed in guide rails equals height of the system -50 mm.
- Fig. 13a shows window frame installation, Fig. 13b shows niche installation.
- Installation of the guide rail must be fixed to the base, as well as it should be linear and perpendicular to Venetian Blind.
- Guide rail profiles must be installed in parallel to each other in all planes.
- Cassettes longer than 3 m are supplied with extensions and cassette angles, as a two-piece element connected by a riveted tab.



SELT Sp. z o.o. company is not responsible for incorrect operation of the blinds with guide rail if the substructure does not provide straight and parallel installation of guide rail profiles.

Recommendations for installation of Venetian Blind with under-plaster cassette.

a) Window frame installation

b) Niche installation

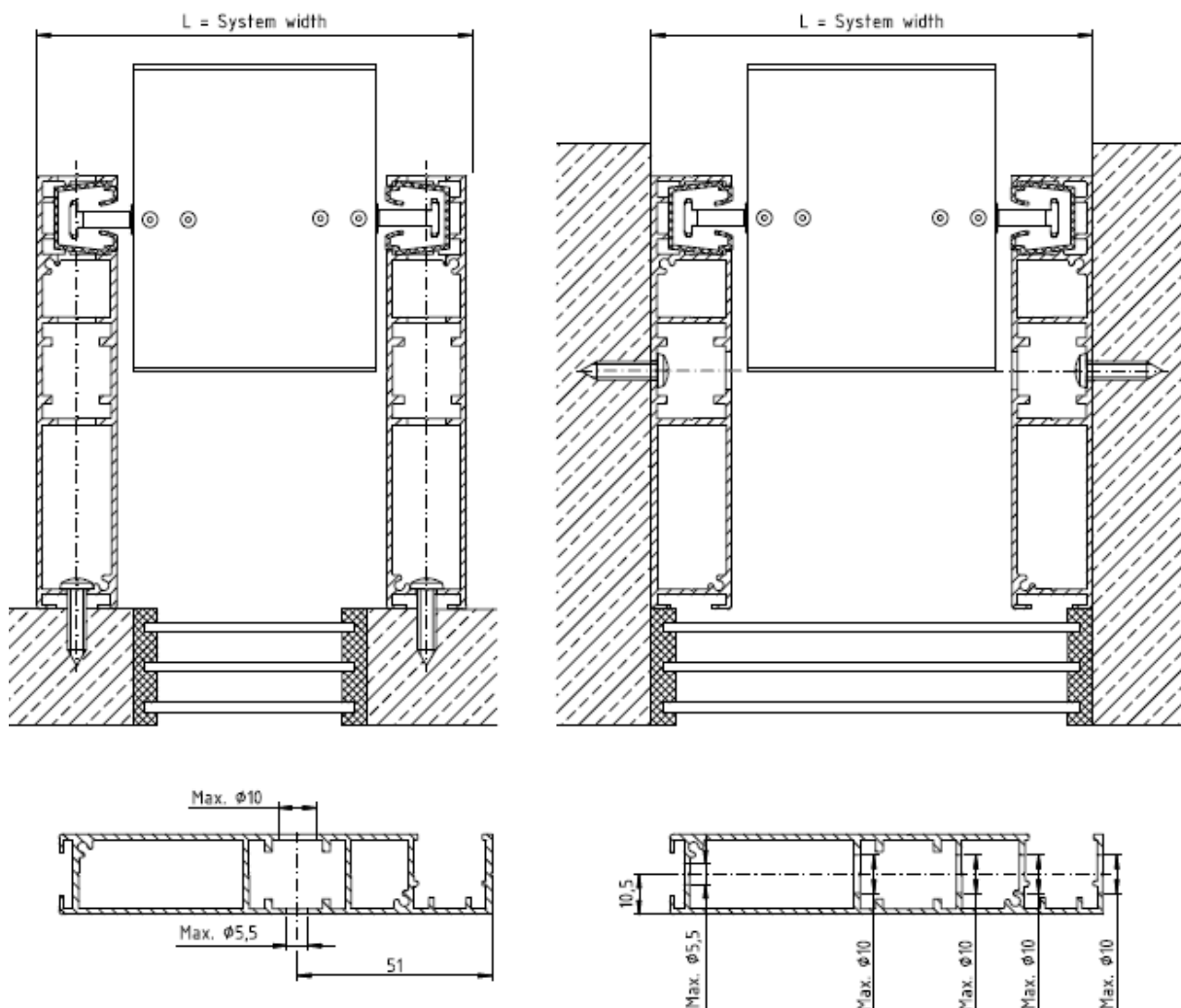

Fig. 13. Guide rail installation: a) – window frame installation b) – niche installation

Instructions for under-plaster cassette installation:

- Under-plaster cassette is delivered without installation holes. They have to be done individually according to the below guidelines (Fig. 14). At least 3 openings are required for each 1m of length of the cassette.
- It is advised to use washers with bigger outer diameter for the installation of the under-plaster cassette, to avoid deformations of the cassette.
- Under-plaster cassette is delivered without hole for feeder cable. It has to be done individually according to the guidelines below. In the side of the cassette drill Ø13 opening and install the choke delivered with the system. Direct the feeder cable through the choke to the cassette.

- Guide rail profiles are delivered without installation holes. They have to be done individually according to the below guidelines (Fig. 13 and 15). At least 3 openings are required for each 1m of length of the guide rail profile. Remember to remove guiding profile when drilling openings in the guide rail.

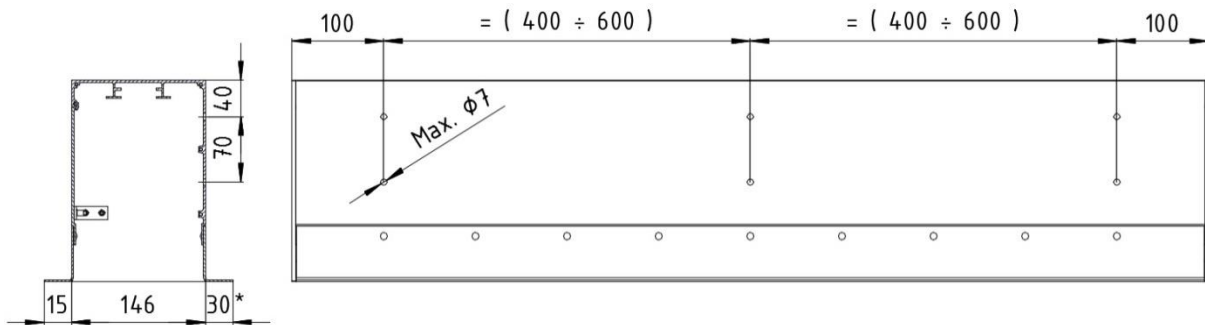

Fig. 14. Scheme of preparation of the installation holes in the under-plaster cassette. * - variable dimension, usually 30 mm.

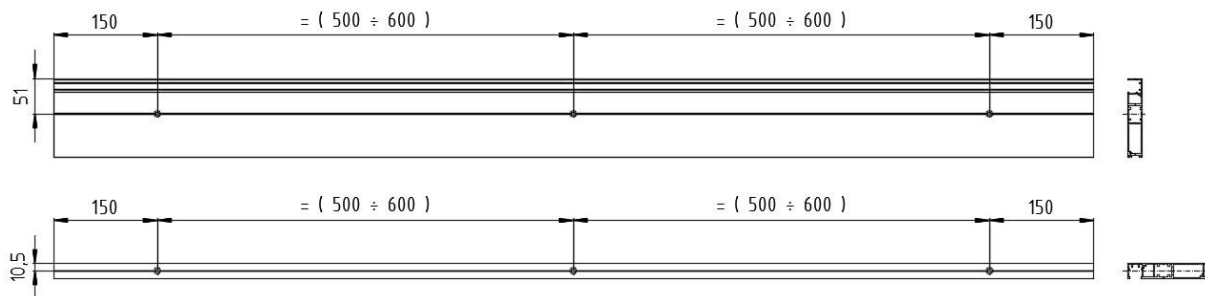

Fig. 15. Scheme of preparation of the installation holes in the guide rail profiles.

b) Installation



Img. 1

1. Measure and mark places for installation holes for the cassette according to - img. 1.
2. Drill installation holes in the cassette in marked places acc. Fig. 14.
3. Drill installation holes for the cassette in the facade.

4. Install the under-plaster cassette to the facade.

NOTE: Under the cassette should be installed insulation (eg polystyrene, etc.) with a thickness of 30 mm. In the insulation on the pins should be installed incompressible spacers, - fig. 16.

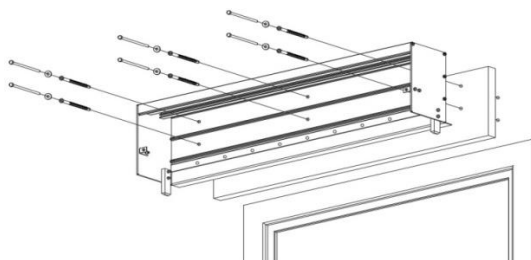

Fig. 16

5. Install head rail brackets in the under-plaster cassette – Fig. 17.

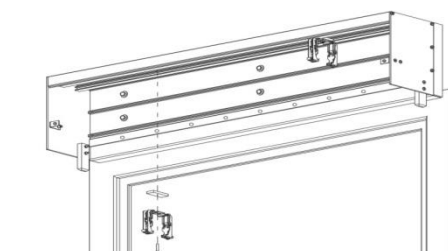

Fig. 17



Img. 2

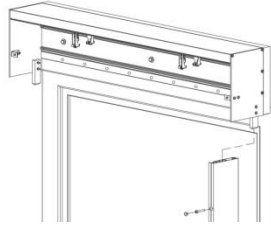

Fig. 18

6. Drill mounting holes in the guide in accordance with Fig.15.

Note: Guide rails can be delivered with the holes if needed. Drilling holes in the guide rails is paid an additional service.

7. Install guide rail to the underplaster cassette and fasten it to base or subconstruction – Fig. 18

8. Loosen screws of the bracket so that it is easy to open.

9. Slide head rail with bundle into the bracket, so that the label „this side to window“ faces the window. Incorrect installation of the bundle will cause incorrect operation of the blind (for easier installation bundle should be chamfered. This will prevent guide rails from scratches made by the pins).

Img. 3



10. Lift up the bundle and install head rail into main brackets.

11. Closed bundle install into elastic brackets and tighten the screws.

Img. 4



12. Place guiding profile into the guide rail according to img. 5 and fig. 18.

NOTE: Special attention has to be paid during placement of guiding profile so that no damage is done to the guiding profile by slat pins.



Img. 5

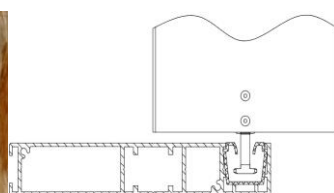

Fig. 18

13. Install guiding profile along full length of the guide rail, acc. Img. 6 and fig. 19.

14. Immobilise the ends of guiding profile with silicone installation glue or silicone hot glue - img. 7.



Img. 6



Img. 7

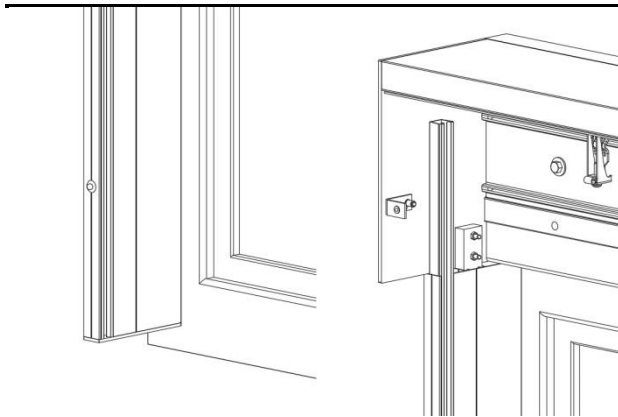

NOTE: Install guiding profile - upper part should freely protrude from the guide rail in the cassette.

Fig. 19

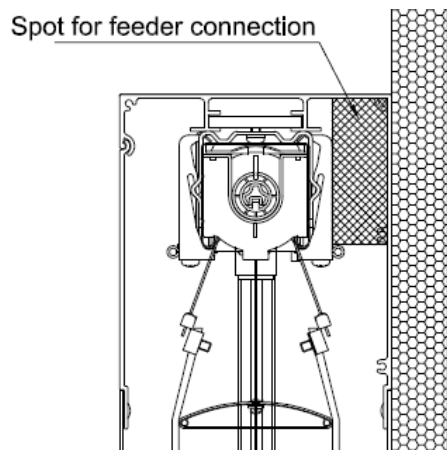

15. Connect feeder cable to the Venetian Blind and check the correctness of system functioning and setting end positions. If necessary correct according to the motor manual.

NOTE: Connection of the feeder cable should be placed in the marked spot in the cassette in a manner enabling maintenance. Cable should be placed in such a way so that no water gets to the motor. The power supply cable must be led through the side of the cassette.

Fig. 20

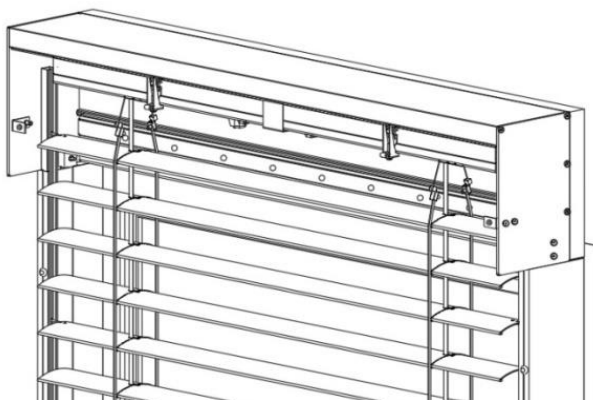

16. Pull up the VB to the upper position, till bundle will hide into the cassette.

Fig. 21



17. Install the revision lid to the under-plaster cassette and secure it with screws.
18. Secure the guide and cassette for the time of insulation and plastering.

NOTE: For proper operation pay attention to keep bundle and guiding profile clean.

Img. 8

4.5.8. INSTALLATION OF VENETIAN BLINDS C80 BOX WITH UNDER - PLASTER CASSETTE BOX3, BOX4, BOX5

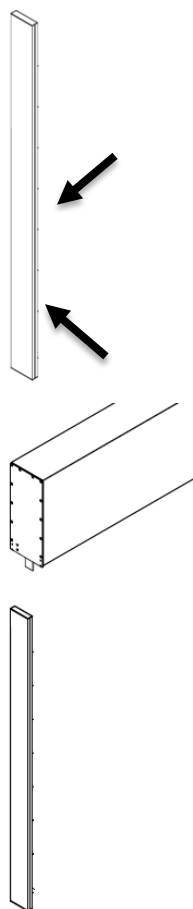

1. Install both guide rails by the proper pins (see page: 30).

Img. 1

2. Place the cassette in the guide rails by inserting the forks.

Img. 2

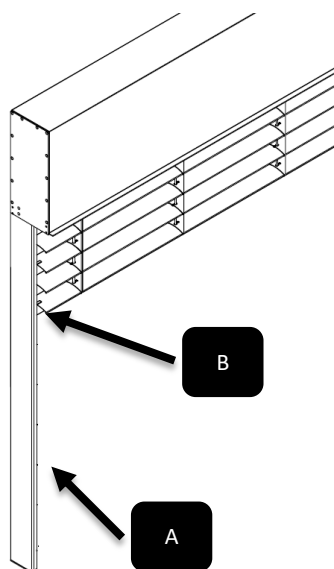

3. Bundle installation see page 32
4. Install guiding profile A into guide rail and the same time insert pins B into guiding profile (see page 32) and Img. 3

Img. 3

4.6. ELECTRIC DRIVE

4.6.1. CONNECTION TO POWER SUPPLY

After the product is installed one may proceed to connecting the drive and control system to the previously prepared systems: power supply and control systems. Connection to the power supply system should be made in accordance with the previously elaborated individual electric diagram, including fire protection regulations. The connection must be performed by an electrician holding appropriate permissions.

Electrical connection and setup of the motors must be done in accordance with the manual of motor manufacturer. Manuals are added to the product as well as are available on motor manufacturer's website and:

www.selt.com → PRODUCTS → AUTOMATION

Environmental conditions of increased threat:

bathrooms and showers, kitchens, garages, cellars, saunas, rooms for domestic animals, operating theatres in hospitals, pump rooms, heat exchange rooms, spaces limited by conducting areas, campsites, open spaces, etc. are regarded as environments with increased threat conditions.

In rooms and spaces where there are increased threat conditions, automatic devices for switching off power supply to the damaged product should be used, e.g. residual current devices. They are recommended to be used in bathrooms, kitchens, garages and cellars. Are obligatory to be used at swimming and shower pools, saunas, construction sites, while supplying appliances in open spaces, on agricultural and horticultural farms, on campsites and in camper vans, as well as in rooms where there is fire hazard.

4.6.2. START-UP AND ADJUSTMENT

- extreme position (up and down movement of the slats) are protected by limit switches that need to be adjusted during the installation,
- adjustment of limit switches must be done in accordance with motor's maintenance manual,
- prior to the first start of the product electrical measurements should be performed,
- do not start the engine without checking the correctness of system installation.

When the product starts working attention should be paid to:

- correct opening and closing of the product
- correct activation of limit switches



Incorrect connection of the motor can lead to product damage or create a hazardous situation.



The engine has a thermal switch, which turns off the drive after about 4 minutes of continuous work to protect against overheating. After turning off by the thermal protection appropriate time should pass before turning on again, depending on the type of engine and atmospheric conditions (about 16 minutes).

4.6.3. MANUAL DRIVE

- Opening, closing and setting slats tilt angle is performed with the use of a crank.
- Do not use excessive force when the blind reaches end position.
- Crank should be secured with crank bracket.

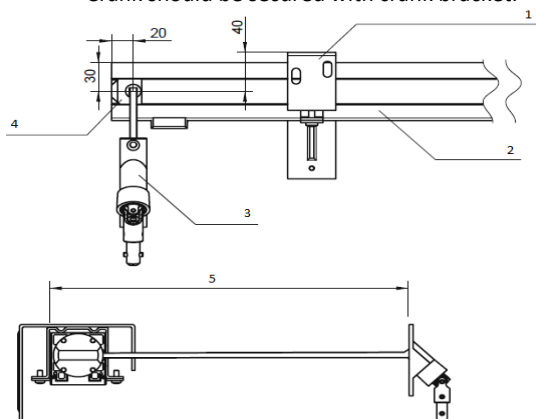

1. Cover panel main bracket
2. Head rail
3. Wall-grommet
4. Gear
5. Max 500mm

5. SYSTEM OPERATION AND PRODUCT SAFETY

5.1. GENERAL SAFETY REQUIREMENTS

- During product transport, assembly and disassembly, operation, care and maintenance, suitable regulations of industrial safety and environmental protection should be observed,
- The product should be maintained and repaired solely by the trained and suitably qualified personnel,

- The Buyer should make sure that people assigned for carrying out activities connected with current use, cleanness and maintenance of the product should be familiar with its operating manual and observe the guidelines in all points of this manual,
- Cleaning the product in a way different from the one described in the part entitled *Technical inspections, maintenance and repairs* is forbidden,
- All work must be carried out with due diligence taking into account safety requirements,
- Maintenance work and product repairs should be carried out only when the product is disconnected from the power source,
- Markings on the product should be observed (e.g. icons, arrows denoting the direction of motion),
- Make sure that markings are not covered with a layer of paint or damaged in a way making it impossible to read them,
- It is forbidden to introduce modification in the electrical design or in the equipment configuration without consulting the manufacturer or an authorised representative,
- Before the product is used, this manual should be read carefully,
- The switch should be mounted at the height conforming to the national regulations concerning disabled persons, not lower than 130cm at best.

5.2. SAFETY REQUIREMENTS CONNECTED WITH PARTICULAR CONDITIONS AND PLACES OF PRODUCT USE.

Particular safety requirements refer to children at the age of up to 42 months. Particular requirements for use apply to all places accessible to little children or places where they spend time. Particular requirements for use apply also to all these places where disabled persons spend time.



Prior to beginning to use the product, the Buyer must carry out individual risk assessment of its use with particular attention paid to the safety of children and disabled persons.

While determining product operational requirements, it is essential to take into consideration rationally predictable conditions of use and potential threats.



Do not allow children to play with the control appliances of the roller blind. Keep the remote control out of the reach of children.



Control the installation frequently for signs of wear or damage to electrical cables. Do not use if repair is necessary.

5.3. OPERATION SAFETY



Product can only be used when it is defect-free.

Recommendations and actions:

- the product is safe for use as long as the recommendations included in the documentation are observed,
- disconnect the product from electrical installation before commencing any work on the building facade, not connected with the maintenance of the product,
- all work connected with inspections and repairs of the product should be carried out by a properly trained person holding adequate qualifications,
- attention should be paid to any signs of wear or damage to electrical cables,
- in case signs of wear or damage to electrical cables are found, the product must not be used, the fault should be reported to supplier immediately,
- the remote control appliances should be kept out of the reach of children,
- entering and staying in the up-down work area of the product should take place only when it is totally open and stopped,
- while folding and unfolding the product, attention should be paid that no objects or people are present within the product work area (in the space between the guides and bottom bar),

- no warm objects (e.g. irons, heaters etc.) shall be kept in proximity of the fabric.

Forbidden actions:

- Do not pull the product and slats up by force. Doing so may result in system damage,
- Stay clear of the work area of the slats while the system is working,
- It is forbidden to use a product not conforming to the electric shock and fire safety requirements,
- It is forbidden to exceed specific work parameters of the product determined in the technical and operational documentation,
- No sharp objects or protruding elements which can hook the bottom bar or slats can be kept near the system,
- it is forbidden to use faulty or incomplete product (e.g. without a switch, tightener), using such product may result in its damage, pose threat to user's health and life,
- It is forbidden to conduct self-repairs,
- It is forbidden to use the product and electrical installation without relevant and required inspections and measurements,
- It is forbidden to take off the electric drive casings,
- Do not touch the movable elements while folding or unfolding the product. It may result in crushing, cutting, pulling in, or blocking between, e.g. the bottom bar and the other structural elements of the system,
- Within the work space of the product there should be no obstacles that might interrupt its work or damage it. In case the product enters an obstacle, first it should be folded slightly and then the obstacle should be removed,
- Stay clear of the work area of the venetian blind while it is working.

Centrally controlled products can activate automatically. Make sure no dangerous situation arises.

SELT Sp. z o. o. shall not be responsible for damage due to improper use.



Operating the system out of one's sight can result in heavy injuries as well as system damage.

WARNING !



Do not use the product in case of strong winds, during snow falls, freezing rain. The product might be destroyed or damaged and create danger to people nearby (refers to products installed externally).

LAUNCHUNG THE PRODUCT IN TEMPERATURES BELOW ZERO MAY CAUSE ITS DAMAGE

In case any irregularities in product operation are found, the Supplier should be informed immediately. Using a damaged product and attempts to repair it on one's own pose threat to health and life and may void the warranty.

5.4. SUPERVISION OF SAFE PRODUCT USE

The Buyer should:

- a) in case safe product use depends on the conditions in which it is installed, submit the product to:
 - preliminary check (after it has been assembled and before handing it over to operation),
 - post-assembly check in another place.
- b) make sure that the product exposed to conditions causing degradation of its technical condition, which may bring about dangerous situations, is submitted to:
 - periodic checks and tests,
 - special check in case it is possible product safety should be worsened due to:
 - modification work,
 - natural phenomena,
 - prolonged downtime,
 - dangerous damage or accidents at work.

The above mentioned checks can be carried out by suitably qualified people.

6. SYSTEM USE AND MAINTENANCE

6.1. USING THE PRODUCT IN ACCORDANCE WITH ITS INTENDED USE

The system should be used in accordance with its intended use determined by the manufacturer. If the system is used and modified in a manner different from the one described within this documentation, the system is used incorrectly. Introducing arbitrary changes influencing safe operation of the product is not acceptable.

The following counts as proper product use:

- regular or predictable use which does not include, e.g. risk undertaken deliberately or consciously by the user,
- applying admissible values of work parameters,
- observing recommendations for use,
- carrying out periodic product inspections and maintenance,
- following the requirements determined in the item 'Supervision of Safe Product Use',
- data included in the item 'Technical Specifications'.

In case of improper use:

- the product can pose threat to its operators,
- the product shall be exposed to damage,
- it can be of negative influence on its functionality,
- do not use the product in the course of maintenance work (e.g. window cleaning).

6.2. INSTRUCTIONS FOR NON-PROFESSIONALS

Prior to beginning to use the product this documentation should be carefully read.

Non-professionals shall denote people who are assigned by the Buyer to carry out activities connected with routine use, cleanness and maintenance of the product.

Being familiar with this documentation guarantees fault-free operation of the product.

List of activities that can be carried out by non-professionals:

- routine operation:
 - carrying out activities which do not influence work parameters of the product,
 - switching on and off by pressing control buttons,
- product maintenance and cleanness described in the further part of this documentation.

6.3. TECHNICAL INSPECTIONS, MAINTENANCE AND REPAIRS

It is recommended to conduct periodic technical inspections of the product carried out by specialised service crews.

The inspections consist in checking product operation, mechanism adjustment, and exchange of wear parts. Routine maintenance is carried out by the User themselves. Product maintenance should be performed at least once (1) a year by specialised service crews.

The inspections are provided against payment.

Basic activities carried out during a periodic inspection:

- Verification of:
 - product mounting to the structural elements,
 - technical condition of the movable elements of the product,
 - condition of electrical cables and inspection of their connection to the electrical system,
 - tension of cable guides and their correction if necessary,
 - screw and rivet connections,
 - technical condition of the slats, guides and seals,
 - mounting of the product drive mechanism (motor, gear),
 - effectiveness of operation of the residual current device.
- Possibly adjusting and improving the mounting of the changed sub-assembly.

Products manufactured by SELT Sp. z o. o. do not require special maintenance treatment. Using the product in accordance with the manufacturer's recommendations assures the user long-term and fault-free operation. Routine maintenance activities should be carried out on a maximally opened system.

Basic product maintenance activities are:

- checking if the venetian blind unfolds and folds properly,
- checking if the end switches work properly,
- cleaning visible, accessible product elements,
- Product maintenance should be performed at least once (1) a year by specialised service crews.

Cleaning metal / aluminum elements:

- Frequency of cleaning depends on weather conditions, proximity of thoroughfare, construction works carried nearby and environmental pollution,
- It is recommended to clean slight dirt of metal / aluminum surfaces with the use of water with delicate cleaning agents,
- Cleaning at least once a year: manually to avoid product damages.

Forbidden activities during product maintenance:

- It is not allowed to use a pressure washer, cleaning agents or solvents,
- It is forbidden to use cleaning agents with the addition of chlorine, ammonia, kerosene, acetone, and bleachers in order to clean the system, as well as in its proximity as it may cause the risk of corrosion,
- It is forbidden to use sharp tools (e.g. wire brushes), scratching cleaning agents (e.g. scouring powders, polish),
- Do not hold or pull the system or its individual elements tight,
- Do not deform the slats.
- Do not replace individual elements! Spare parts should be original!
- Do not let the water to get into system head rail.

7. GENERAL WARRANTY CONDITIONS

General warranty conditions are available on www.selt.com. In case of no access to the SELT website, the warranty conditions can be obtained from the sales representative of SELT Sp. z o. o

7.1. EXCLUSIONS FOR WARRANTY**Warranty does not cover:**

- Damages resulting from transport other than SELT,
- Damages resulting from storage, installation or maintenance activities other than described in the technical and operational documentation or Supplier recommendations, unless those activities were conducted or advised by the Supplier,
- Damages resulting from failure to observe Supplier recommendations contained in the technical and operational documentation of the product,
- Mechanical damages,
- Damages resulting from self-modifications conducted by the user, unless it was done by the Supplier, or on behalf of the Supplier, or with its written permission,
- Secondary damages resulting from using the product regardless of the noticed faults, unless the Supplier was notified about it and recommended further use. The assessment of damage causes is left to the rational recognition of the Supplier. Repair or change of the product due to the damages described herein can be done by the Supplier against payment.
- Faults resulting from normal wear of product parts, including: seals, lubricants, etc.,
- Repairs involving regulation, cleaning and lubrication,
- Electrical devices delivered to the Supplier in a manner not allowing for operation check (e.g. cut off motor cable, receiver in parts),
- Damages resulting from incorrect installation of the product, self-repairs and adjustments,
- Damages resulting from using the product in incorrect weather conditions,
- Damages resulting from incorrect cleaning with the use of caustic and grinding products or inappropriate devices.
- Atmospheric and phytosanitary pollution
- Effects resulting from hanging on the blind other products or objects, that are not related to Selt systems.
- Bottom bar contortion resulting from tucking or twisting of the flat cord..
- Uneven tilting of one or more of the blinds in case of modular installation with one motor (non-collinear operation of the blinds within one module),
- Uneven tilt of the slats between particular modules installed on one facade, for modules driven with separate motors and common operation. The difference between tilt might be up to 20° and cause visible effect of uneven position of slats in particular modules,

- „Arrow effect” which can appear in narrow and high venetian blinds, when during rolling up the ladder string gets between the slats causing the bundle to appear thicker on one side,
- Bottom bar deflection in case of very wide blinds
- Incomplete closure of lower slats in case of very high venetian blinds. This does not cause the incorrect operation of the product,
- Asymmetrical behaviour of elements cooperating within one venetian blind or module (e.g. bottom bar) due to manufacturer’s production tolerances and physical properties of textiles used,
- Venetian Blind with illumination effect cannot be connected to operation system using Sun Tracking option.
- Powder RAL 7016 mat used by the company SELT Sp. z o.o. has Qualicoat approval with No. P-1281. The powder is used in accordance with the technical data sheet of the product. The powder is specially selected to be very flexible - which is necessary in our production process, and consequently is softer and thus may be visible scratches on its surface as a result of transport or use of painted elements - which is unavoidable.

Tolerance of execution

Due to the manufacturing tolerances, differences in the length of the cover sheets and their bends up to 5mm are permissible, as per the pictures below. Tolerances are not the basis for the complaint



Img. 1. Bends of the sheets

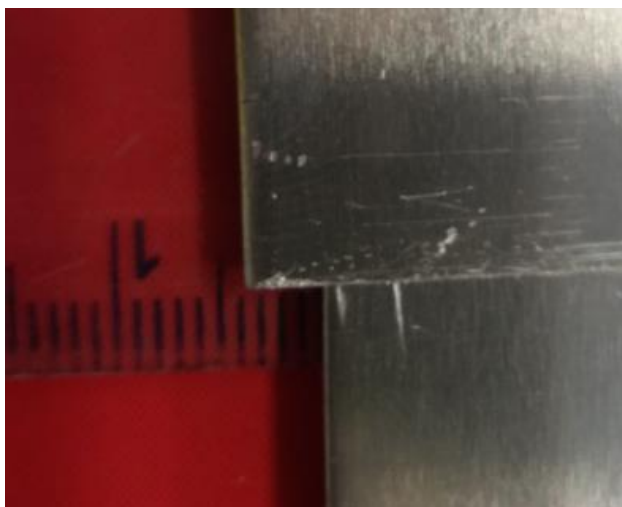

Img. 2. Length of the sheets

8. COMPLAINTS/ TECHNICAL FAULTS

8.1. COMPLAINTS

Complaint lodging procedure:

- A complaint shall be lodged in a written form in the point of sale where the purchase was made,
- Submitting the contract, order or invoice number, as well as a written complaint notification and warranty card are the conditions for accepting the complaint.
- The notification should include a detailed description of the defect, the name of the company which assembled the product and the date of finding out the defect.

Product with no invoice number, order or contract number will be considered as post-warranty product..

8.2. TECHNICAL FAULTS

In case product defects occur, one should:

- fold the product and put it out of service,
- immediately notify the dealer about the product fault.
- notifications can be sent to the email address reklamacje@selt.com or directly to the sales representative.

Complaints / faults should be made on the 'complaint notification form' which can be found on the website: www.selt.com, or directly at the customer's assistant.

9. PRODUCT DISASSEMBLY / UTILISATION / DISPOSAL



Improper system disassembly can result in severe injuries and system damage. System disassembly should be commissioned to a properly qualified assembly team or to a person suitably trained within industrial safety and with the knowledge concerning recovery.

a) Disposal of worn electrical and electronic equipment

After the end of product lifetime it must be disassembled and separate material must be segregated according to Regulation of the Minister of Environment of 9 December 2014 on waste catalogue – Dz. U. [Journal of Laws] of 2014 item 1923.

Important information concerning utilisation:

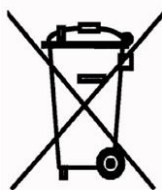

Pursuant to the regulations of the Act dated of 11 September 2015 about waste electrical or electronic equipment, it is forbidden to place used appliances marked with a crossed out waste bin symbol jointly with other waste. The User wishing to dispose of electronic or electrical equipment is obliged to take it to the used equipment collection spot.

The above legal obligations were introduced in order to reduce the amount of waste due to used electrical and electronic equipment and to assure a proper level of collection, recovery and recycling. There are dangerous elements in the equipment which are of particularly adverse effect on the environment and human health.

No.	Subject	European legal basis	Polish legal basis
1	Waste electrical and electronic equipment	Directive 2012/19 EU of the European Parliament and of the Council of 4 July 2012 on waste electrical and electronic equipment (WEEE)	Act of 11 September 2015 Dz. U. [Journal of Laws] of 2015, item 1688 on waste electrical and electronic equipment
2	Waste catalogue	Commission Regulation (EC) No. 574/2004 of 23 February 2004 amending Annexes I and III to Regulation (EC) No. 2150/2002 of the European Parliament and of the Council on waste statistics	Regulation of the Minister of Environment of 9 December 2014 on waste catalogue – Dz. U. [Journal of Laws] of 2014 item 1923

b) Disposal of waste batteries

In accordance to the Act of 24 April 2009 on batteries and accumulators final user is obliged to pass waste portable batteries, which are no longer energy source, to a collection spot or to a special collection bin. It is forbidden to put waste batteries in the same container as other waste.

In order to prevent environment pollution and posing possible threat to human and animal health, dispose of the used battery to a proper collection bin in the assigned collection spots.

Lp.	Przedmiot	Europejska Podstawa Prawna	Polska Podstawa Prawna
1	Waste batteries and accumulators	Directive 2006/66/EU of the European Parliament and of the Council of 6 September 2006 on waste batteries and accumulators and repealing directive 91/157/EEC	Act of 24 April 2009 on batteries and accumulators Dz. U. [Journal of Laws] of 2009 no. 79, item 666

10. MARKING AND LABELLING THE PRODUCT WITH THE CE MARK

10.1. PRODUCT COMPLIANCE WITH THE CE STANDARD

Products manufactured by SELT company meet the essential requirements of the standard introduced by the Polish Committee for Standardization as PN-EN 13659, which is confirmed by the manufacturer's declaration of performance and marking the product with the CE mark.

In order to maintain this condition and assure safe use and maintenance of the system, the installation and operating manual and instructions for safe use must be observed.

10.2. INFORMATION ACCOMPANYING THE CE MARKING

a) Marking on the product:

SELT Sp. z o. o. Opole, ul. Wschodnia 23A
EN 13659

SELT Sp. z o. o. Opole, ul. Wschodnia 23A
2006/42/WE

b) Marking on the accompanying documents:

SELT Sp. z o. o. Opole, ul. Wschodnia 23A POLAND 12
EN 13659 Venetian Blinds C 80 500x580 For external use. Wind load resistance: class 0 Additional thermal resistance: $\Delta R=0,0$ Total solar energy transmittance g tot: 0,01-0,90* DWU 79 / ŻF / 2017
*- external sun protection screen with glazing type C according to EN 14501:2005; detailed data depending on the fabric type are given in a table on manufacturer's website

SELT Sp. z o. o. Opole, ul. Wschodnia 23A POLAND 12
Venetian Blinds C80 (cable and aluminium guide version) C80 ^{BOX} (version BOX1 i BOX2) 230V/ 50 Hz Power 90 do 230 W 06 / DZ/2018



SELT Sp. z o. o.
Opole, ul. Wschodnia 23A
POLAND
12

EN13659
Venetian Blinds C80, C80L for external use
DWU 72/ŻF/2018

Essential characteristics					Performance	Harmonised technical specification
Resistance to wind load					Class (pressure)	
Type	Width [cm]	Height [cm]	Guide	Drive		
C80L	up to 350	up to 240	Cable guide	Crank	Class 1 (75 Pa)	EN 13659:2015
	up to 220	up to 400				
	Max. surface up to do 9 m ²					
C80L	up to 350	up to 400	Cable guide	Motor	Class 1 (75 Pa)	
C80	up to 450	up to 200	Guide rail	Crank	Class 3 (150 Pa)	
	up to 180	up to 500				
	Max. surface up to 9 m ²					
C80 ¹⁾	450	500	Guide rail	Motor	Class 3 (150 Pa)	
Additional thermal resistance ΔR					0,0	
Total solar energy transmittance g_{tot}					0,01-0,90*	

1) including perforated slats

* - external sun protection system together with type C glazing according to EN14501:2005; details depend on the colour of the slats-given in tables on the website of the manufacturer



SELT Sp. z o. o.
Opole, ul. Wschodnia 23A
POLAND
18

EN13659
Venetian Blinds (fasadowa) C80 MIX for external use, with mixed side guides
DWU 84/ŻF/2018

Essential characteristics					Performance	Harmonised technical specification	
Resistance to wind load					Class (pressure)		
Type	Width [cm]	Height [cm]	Side Guide	Drive			
C80MIX	up to 350	up to 240	Cable guide+ Guide rail	Crank	Class 0 (<75 Pa)	EN 13659:2015	
	up to 220	up to 400					
	Max. surface up to 9 m ²						
C80MIX	up to 350	up to 400	Cable guide+ Guide rail	Motor	Class 0 (<75 Pa)		
Additional thermal resistance ΔR					0,0		
Total solar energy transmittance g_{tot}					0,01-0,90*		

* - external sun protection system together with type C glazing according to EN14501:2005; details depend on the colour of the slats-given in tables on the website of the manufacturer



SELT Sp. z o. o.
Opole, ul. Wschodnia 23A
POLAND
17

EN 13659
Venetian Blinds C80^{BOX}.450x300
For external use .
Wind load resistance: class 3
Additional thermal resistance : $\Delta R=0,0$
Total solar energy transmittance
g tot: 0,01-0,90*
DWU 73 / ŻF / 2019

*- external sun protection screen with glazing type C according to EN 14501:2005; detailed data depending on the fabric type are given in a table on manufacturer's website